

Grease separator EasyClean ground NS 2, Direct, 550-950 mm, D, left

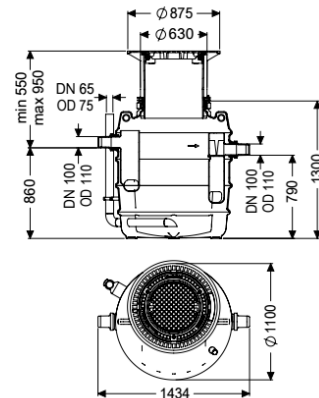

Article information

Item no.: 93002.80D-DL
 GTIN: 4026092095058
 Price group: 60

Advantages

- Low odour and clean disposal
- Defined disposal point
- Complete emptying of the separator

Description

The separator for greasy wastewater is suitable for installation in the ground and comes without metallic components in the tank. The collecting tank made of permanently resistant polymer (PE) is equipped with an integrated sludge trap and has a rounded base for fast and clean disposal. Access for cleaning and maintenance work is possible via one or several service access covers. A direct disposal pipe socket is available for odour-reduced manual disposal. A load distribution slab must be installed on site for load class D. The reinforcement drawings are available from KESSEL. 20 year polyethylene warranty.

Variant

Note on installation depth:	Installation in the ground, frost-free depth 800 mm
Direction of flow:	left
Disposal variant:	Direct
Nominal size (NS):	2
Disposal system:	Disposal pipe
Type of disposal:	manual
Load-bearing capacity (DIN 19901):	E4

General characteristics

Material:	PE
Installation situation:	underground installation
Delivery state:	Installation-ready (connection parts must be connected on site)

Dimensions

Net weight:	120 kg
Gross weight:	127 kg
Groundwater resistant from lower edge of base section:	500 mm
Diameter:	648 mm
Installation depth:	550 - 900 mm
Length:	1380 mm
Width:	1106 mm
Packaging dimension:	length
Packaging dimension:	width
Packaging dimension:	height

Tank/drain body

Distance pipe bottom outlet to tank bottom:	790 mm
Distance pipe bottom inlet to tank bottom:	860 mm
Outlet nominal size (DN):	100 mm
Inlet nominal size (DN):	100 mm
Connection inlet/outlet sockets:	PE-HD pipes in accordance with DIN 19537, PVC-KG pipes in accordance with DIN 19534, PP or AS
Clear width of entry (LW):	600 mm

Coverage features

Type of cover:	Cover plate
Cover material:	Grey iron
Colour of cover:	black
Load class:	D 400 (EN 124)
Tightness:	odour-tight and surface water resistant

Wastewater contents

Separator contents:	370 l
Contents of sludge trap:	200 l
Storage quantity of grease:	120 l
Storage quantity of light liquid:	120 l