

Grease separator EasyClean ground NS 2, Auto Mix & Pump, 1260-1700 mm, A/B

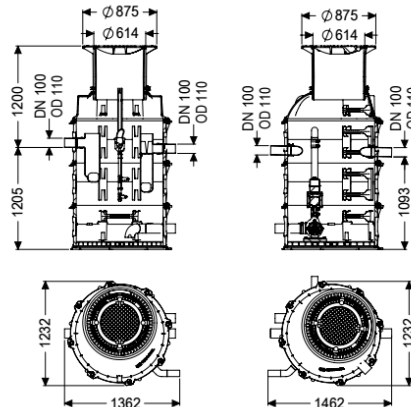

Article information

Item no.: 93002/170B-PVS-TS
 GTIN:
 Price group: 60

Advantages

- Fully automated disposal and rinsing device
- Customisation possible through control unit
- Clean and odour-free disposal and cleaning

Description

The separator for greasy wastewater for underground installation consists of a grease separator and an engineering chamber. The two-piece system made of permanently resistant polymer (PE) is equipped with an integrated sludge trap and an integrated sampling device. Access for cleaning and maintenance work is provided by inspection openings, with polymer upper sections for continuously adjustable height and level compensation. The innovative Shredder-Mix-System with integrated macerating system is responsible for homogenising and circulating the tank contents. Cleaning and odour-neutral disposal takes place via an exterior submersible pump which is installed in a separate engineering chamber and can be disconnected from the tank by a shut-off valve. The fully automatic program run is controlled by a user-friendly control unit with multi-line display that can be integrated into the building management system through a potential-free contact. The control unit with 10 m long cable is installed in the engineering chamber in the factory. Cleaning and disposal can be started remotely using the remote control. Thanks to the customisable cleaning program with fast-selection function, cleaning can be adapted to the local circumstances as required. Observance of the Drinking Water Hygiene Directive can be guaranteed through the fully automatic rinsing of the drinking water pipes. The refill inlet and solenoid valves must be installed in a dry room on site. The connections between the grease separator and the engineering chamber as well as the reserve conduits and the connections must be made on site. (see connection set 917421). A load distribution slab must be installed on site for load class D. The reinforcement drawings are available from KESSEL. 20 year polyethylene warranty.

Variant	
Note on installation depth:	Ground installation frost-free depth 1700 mm
Shut-off valve:	yes
Disposal variant:	Auto Mix & Pump
Shredder-Mix-System:	yes
Sludge bucket:	no
Nominal size (NS):	2
SonicControl:	no
Disposal system:	Disposal pump
Refill inlet in accordance with DIN 1988:	yes
Type of disposal:	automatic disposal and cleaning system
Water supply:	2 solenoid valves 1"
Sampling device:	Type NBG
Load-bearing capacity (DIN 19901):	E2
General characteristics	
Standard:	EN 1825
Installation situation:	underground installation
Dimensions	
Net weight:	490 kg
Gross weight:	510 kg
Groundwater resistant from lower edge of base section:	3000 mm
Diameter:	648 mm
Max. length:	2790 mm
Installation depth:	1260 - 1700 mm
Required access area, length:	1425 mm
Required access area, width:	1235 mm
Tank/drain body	
Distance pipe bottom outlet to tank bottom:	845 mm
Distance pipe bottom inlet to tank bottom:	955 mm
Outlet nominal size (OD):	110 mm
Outlet nominal size (DN):	100 mm
Inlet nominal size (OD):	110 mm
Inlet nominal size (DN):	100 mm
Connection inlet/outlet sockets:	PE-HD pipes in accordance with DIN 19537, PVC-KG pipes in accordance with DIN 19534, PP or AS
Clear width of tank (LW):	1000 mm
Clear width of entry (LW):	600 mm
Coverage features	
Type of cover:	Cover plate
Cover material:	Grey iron
Colour of cover:	black
Locking:	unlocked
Load class:	B 125 (EN 124)
Tightness:	odour-tight and surface water resistant

Wastewater contents	
Separator contents:	370 l
Total volume:	570 l
Contents of sludge trap:	200 l
Storage quantity of grease:	120 l
Pumping device	
Pump:	SPF 300 IP68
Number of pumps:	1
Weight, pump:	44 kg
Connection type:	Direct connection
Rated current:	6,2 A
Length of mains cable for pump:	5 m
Protection class:	I
Insulation class:	F
Protection class (pump):	IP 68
Temperature monitoring:	integrated
Max. temperature (permanent) of conveyed material:	40 °C
Max. pumping capacity:	60 m ³ /h
Max. pumping height:	17 m
Speed:	2850 U/min
Power P1:	3,6 kW
Power P2:	3 kW
Operating mode:	S2 - 30 min.
Type of fuse required (electrical protection):	Fuse protection through control unit 400 V
Type of pump connection cable:	H07RN-F 7G 1.5 mm ²
Impeller type:	Radial impeller with macerating system
Control	
Control unit:	yes
Motor protection switch:	yes
Type of fuse required (RCD):	30 mA
Protection class control unit:	IP 54
Mains frequency:	50 Hz
Operating voltage:	400 V
Connection type:	Direct connection
Potential-free contact:	yes
GSM interface:	no
USB interface:	yes
Log book function:	yes
Multi-line display:	yes
Battery buffering:	no
Self-diagnosis system (SDS):	yes
Rated current:	6,2 A